

LED PENDANT HIGHBAY MLLHP SERIES



Narrow Model



Wide Model



Side View

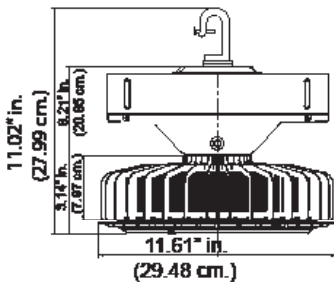

140W

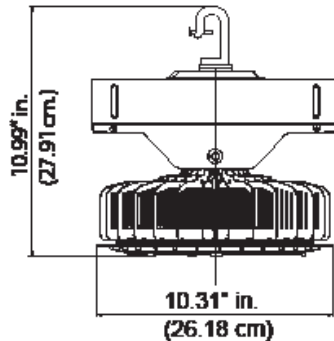

85W



PRODUCT DESCRIPTION:

The MaxLED HighBay LED fixtures are designed for 25-foot and higher ceiling applications in warehouses, gymnasiums, general manufacturing and general task areas. With an enclosed power supply housing and covered optics, these units are designed for durability in difficult installation locations.

FEATURES:

- Full polycarbonate lens cover
- Annular polished optic collimator for 70 degree beam angle at Narrow models
- Radial aluminum heat sink fins
- Enclosed wiring and driver compartment
- Slide out driver tray service feature enables the fixture to remain hanging
- Standard hook attachment provided
- Indoor/Damp rated

CONSTRUCTION:

- Aluminum housing
- Aluminum heat sink finning
- Polycarbonate lens

CONTROL:

- 0-10V Dimming

WARRANTY:

10-year standard warranty with labor allowance* (further details available at www.maxlite.com/warranties)
*Warranty Limitations: Product must be rated for the application per the Product Data Sheet (PDS); operated ≤ 16 hrs; in ambient of -29F to 104F.

*Up to \$25/unit; labor allowances of up to \$500/unit available for purchase – contact MaxLite representative for details.

MODEL SELECTION (Full list of order codes on pg. 2)

Typical order example: MLLHP085USD12/W

MLLHP					
FAMILY	WATTAGE (NOMINAL)	VOLTAGE & SIZE	MOUNTING	DISTRIBUTION	OPTIONS
MLLHP= LED Pendant HighBay Series	085= 85W ¹ 140= 140W	USD12= 120-277V & 12" diameter	(OMIT)= Hook	N= Narrow W= Wide	(OMIT)= None EM= Battery Backup Unit MSO= Motion Sensor (On/Off) MSV= Motion Sensor (Bi-Level)

NOTES:





1. 85W is not DLC qualified
2. EM,MSO and MSV are not compatible with 85W

ORDERING*:

ORDER CODE	MODEL NUMBER	DISTRIBUTION	OPTION	WATTAGE
1408261	MLLHP085USD12/W	HIGHBAY PENDANT ROUND 85W 120-277VAC 5000K WIDE FLOOD	85W	Wide
1408262	MLLHP085USD12/N	HIGHBAY PENDANT ROUND 85W 120-277VAC 5000K NARROW FLOOD		Narrow
1408263	MLLHP140USD12/W	HIGHBAY PENDANT ROUND 140W 120-277VAC 5000K WIDE FLOOD	140W	Wide
1408264	MLLHP140USD12/N	HIGHBAY PENDANT ROUND 140W 120-277VAC 5000K NARROW FLOOD		Narrow

SPECIFICATIONS:

		MLLHP085USD12/W	MLLHP085USD12/N	MLLHP140USD12/W	MLLHP140USD12/N
ITEM	SPECIFICATION	DETAILS			
GENERAL PERFORMANCE	Power Consumption (W)	85	85	146.1	145.4
	Lumens Delivered (lm)	11,900	11,500	20,490	19,730
	Efficacy (lm/W)	140	135	140	135
	Beam Angle	110°	70°	110°	70°
	CRI	≥80			
	Color Temperature (K)	5000K			
ELECTRICAL	L70 Lifetime (hours)	>50,000 hours			
	Power Factor	≥0.9			
	Input Voltage (V)	120-277V Standard hook			
	Mounting	Standard hook			
PHYSICAL	Weight	7.5lbs (3.4kg) (opt. models - check with MaxLite)			
	Housing	Aluminum			
	Lens	Polycarbonate			
	Dimensions	10" Ht.*w/loop x 11.75" DIA (opt. models - check with MaxLite)			
	Operating Temperature	-34°C to 50°C (-30°F to 120°F)			
	Humidity	10-90% RH, non-condensing			
QUALIFICATION	Qualification	cULus, FCC, DLC 4.1 Premium			
	Material Usage	RoHS compliant, no mercury			
	Environment	Indoor/Damp Rated			
	Warranty	10 year warranty*			

ACCESSORIES			
ORDER CODE	MODEL NUMBER	DESCRIPTION	PRODUCT IMAGE
77496	MLLHPWG12W	Wire Guard for 140W, White, 12" Diameter	
76503	MLRSKHBP36X1/2W	Stem Kit Highbay Pendant Monopoint 36in x 1/2 IPS White	
97821	MLLHPSTMBK	Stem Mount Bracket	
14099174	MLLHP085-SHADE14	Polycarbonate Shade for MLLHP 85W, 14" Bottom Diameter	
1409203	MLLHP-SHADE17	Polycarbonate Shade for MLLHP 140W, 17" Bottom Diameter	

NOTES:

1. Wire guard not compatible with shade
2. No wire guard available for 85W